



7500 FR Series FLOOR ACCESS COVERS



For all bespoke requirements, our technical team will assist you to determine the correct specification and dimensions for your project.

+44(0)1920 463 230

info@howegreen.co.uk

Fire rated, aluminium floor access covers for hard finishes

» FEATURES & BENEFITS

- Independently fire rated to BS 476 Part 22, *certified for up to 2 hours on integrity and 1 hour on insulation
- Covers can be fitted quickly and unobtrusively into all types of hard floor finishes: ceramic tiles, marble, terrazzo, resin or parquet
- Medium duty access cover, up to 5 tonne pneumatic tyre wheel load, FACTA B (cars and light delivery vehicles)
- Unique patented cover sections are tapered for easy removal, and frame sections give a good key to bedding mortar
- Triple sealed covers with socket head securing bolts as standard
- A top edge dirt seal helps to prevent dirt, grout or grinding waste penetrating the joint between the cover and the frame
- Lifting blocks are anchored to the inner frame
- Stainless steel securing bolts are stiletto heel proof

» 7500 FR SERIES ALUMINIUM FLOOR ACCESS COVERS

Size

- Precision-made to measure using the Howe Green patented system to avoid distortion
- Manufactured in any size between the stated maximum and minimum dimensions
- Available as a single cover, ducts with branches or multi -part configuration
- Manufactured in the UK to BS EN ISO 9001

Weight

- A 7500 FR Series floor access cover weighs approx. 155kg/m² when filled with concrete
- The weight of the access cover should be taken into account where ease of handling is an important consideration
- In all cases reference should be made to the Manual Handling Operations regulations 1992, which implement European Directive 90/269/EEC
- Howe Green's Cover Skate provides a safe and easy method of lifting and moving heavy floor access covers

*when filled with C40 concrete, in a deadload environment. Certified for integrity only when filled with a tile, slab or stone infill

7500 FR Series ALUMINIUM SINGLE COVER

» FLOOR ACCESS COVERS FOR CARS AND LIGHT DELIVERY VEHICLES

Typical floor finishes

- Ceramic tiles, marble, terrazzo, concrete, resin, wood and all hard floors

Performance

- Medium duty, up to 5 tonne pneumatic tyre wheel load, FACTA B (cars and light delivery vehicles)
- More information can be found at www.howegreen.com

Options

- Stainless steel or steel baseplate and reinforcement
- Unsealed with blanking bolts

See www.howegreen.com for more information

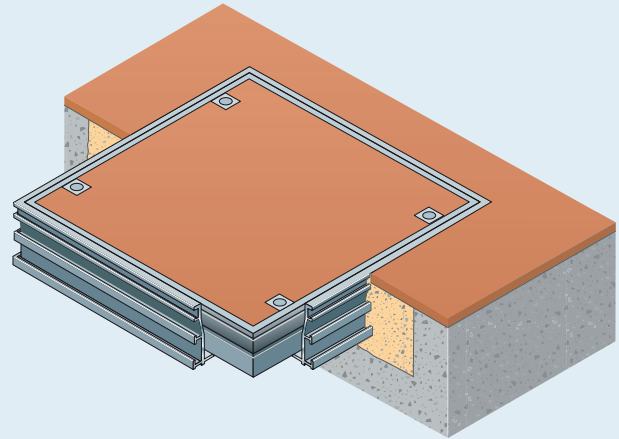

Cross section showing concrete and timber sub-floors (scale 1:2)

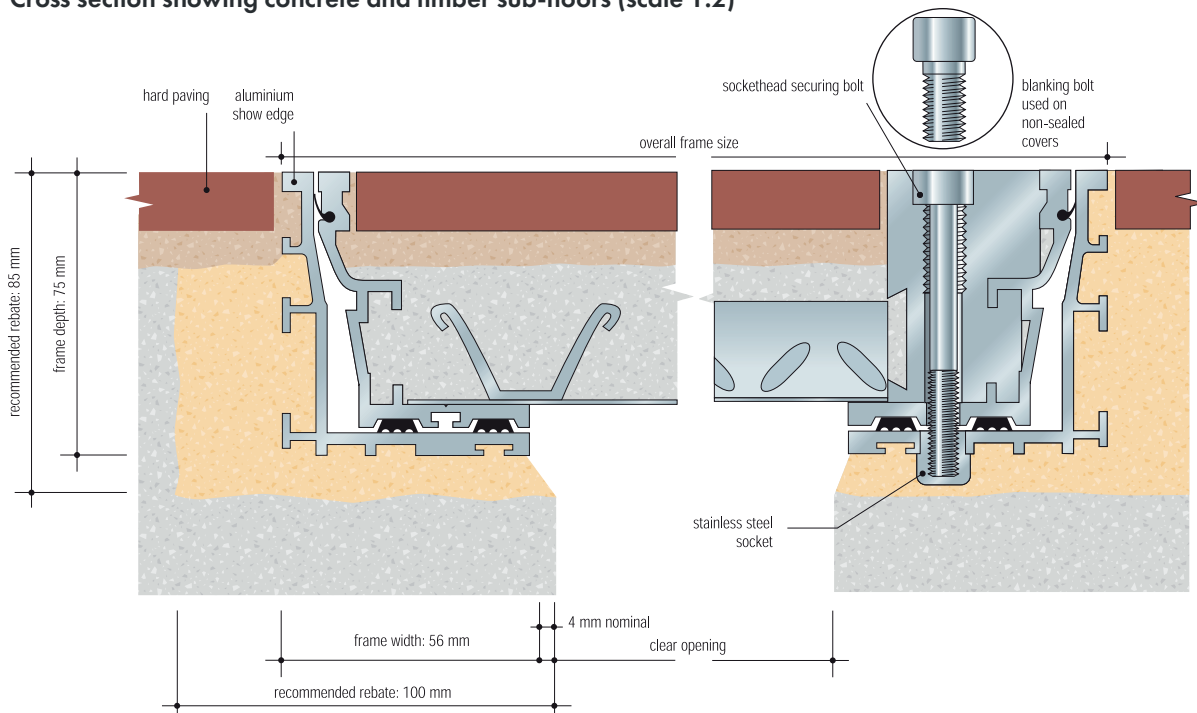

Size

- Overall frame size = clear opening + 120 mm
eg 600 x 900 mm clear opening = 720 x 1020 mm overall frame. Subject to correct infill/installation.

Weight

- A 7500 FR Series cover when filled with concrete weighs approx. 155kg/m².

Fire Rating

- Max size 1020mm X 1020mm = 900mm X 900mm clear opening.
Fire rated to BS 476 PART 22, certified for 2 HOURS on integrity and 1 HOUR on insulation, when filled with C40 concrete in a deadload environment. Certified for integrity only when finished with a tile, slab or stone infill.

Maximum / minimum sizes

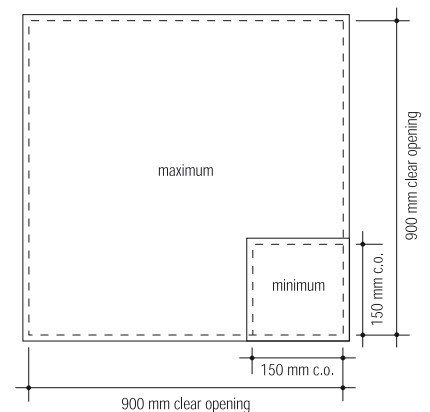

7500 FR Series ALUMINIUM DUCT COVER

» FLOOR ACCESS COVERS FOR CARS AND LIGHT DELIVERY VEHICLES

Typical floor finishes

- Ceramic tiles, marble, terrazzo, concrete, resin, wood and all hard floors

Performance

- Medium duty, up to 5 tonne pneumatic tyre wheel load, FACTA B (cars and light delivery vehicles)
- More information can be found at www.howegreen.com

Options

See www.howegreen.com for more information

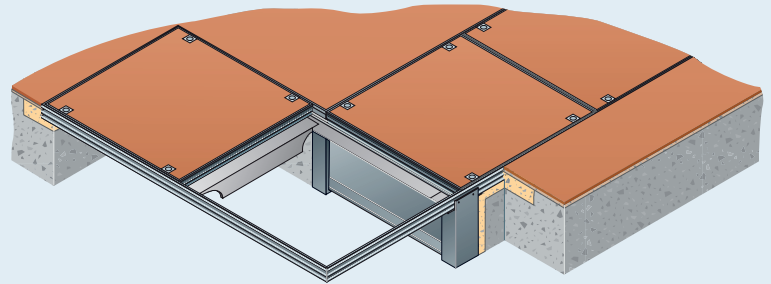

Cross section showing anchor lugs and locking/lifting detail (scale 1:2)

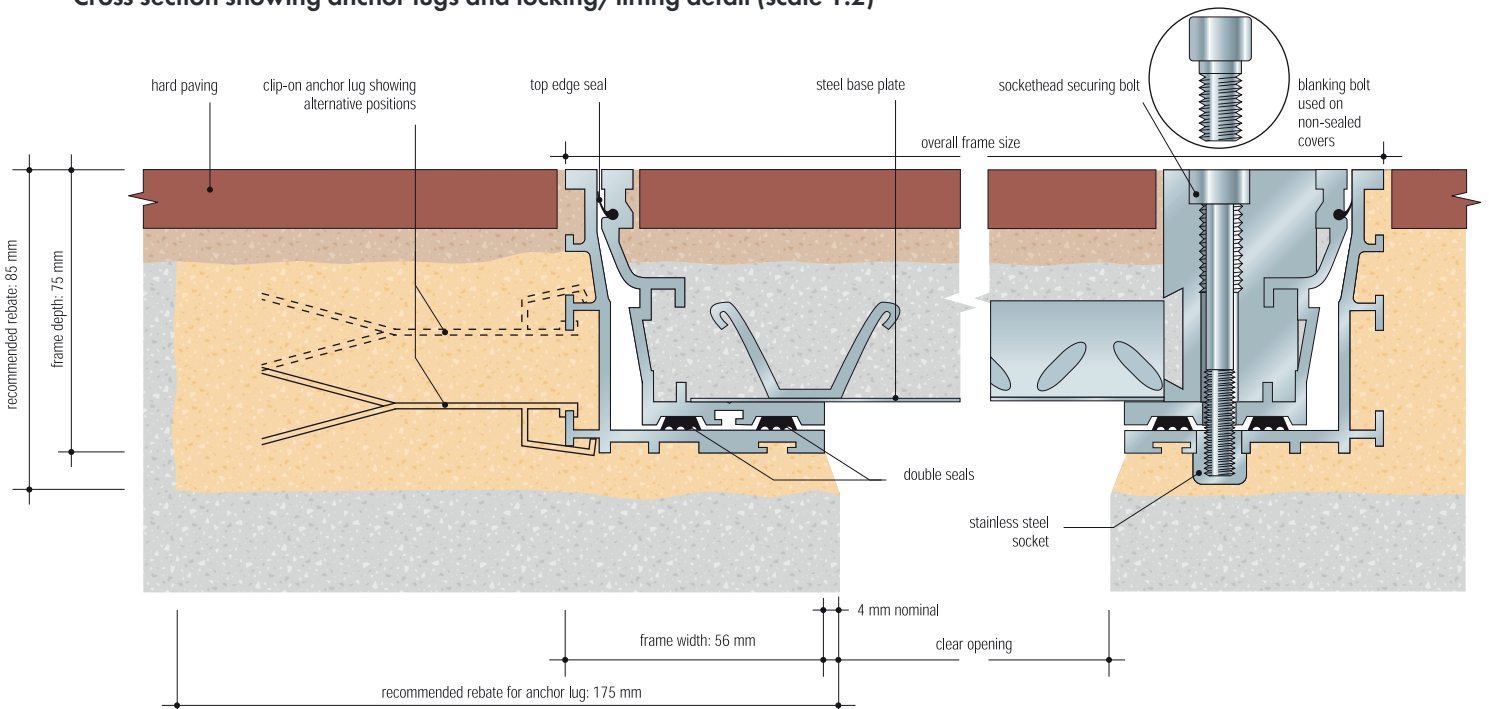

Size

- Overall frame size = clear opening + 120 mm e.g. 550 mm clear opening = 670 mm overall frame width. Subject to correct infill/installation.

Weight

- A 7500 FR Series cover when filled with concrete weighs approx. 155kg/m².

Fire Rating

- Max width 1020mm = 900mm clear opening x unlimited duct run length and branches.

Fire rated to BS 476 PART 22, certified for 2 HOURS on integrity and 1 HOUR on insulation, when filled with C40 concrete in a deadload environment. Certified for integrity only when finished with a tile, slab or stone infill.

Typical layout

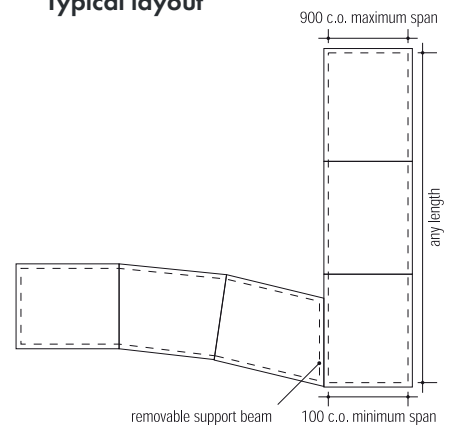

7500 FR Series ALUMINIUM MULTIPART COVER

» FLOOR ACCESS COVERS FOR CARS AND LIGHT DELIVERY VEHICLES

Typical floor finishes

- Ceramic tiles, marble, terrazzo, concrete, resin, wood and all hard floors

Performance

- Medium duty, up to 5 tonne pneumatic tyre wheel load, FACTA B (cars and light delivery vehicles)
- More information can be found at www.howegreen.com

Options

See www.howegreen.com for more information

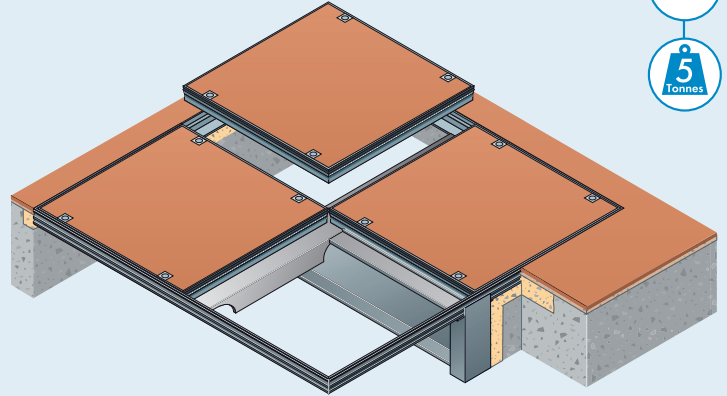

Cross section showing removable support beam and cross members (scale 1:5)

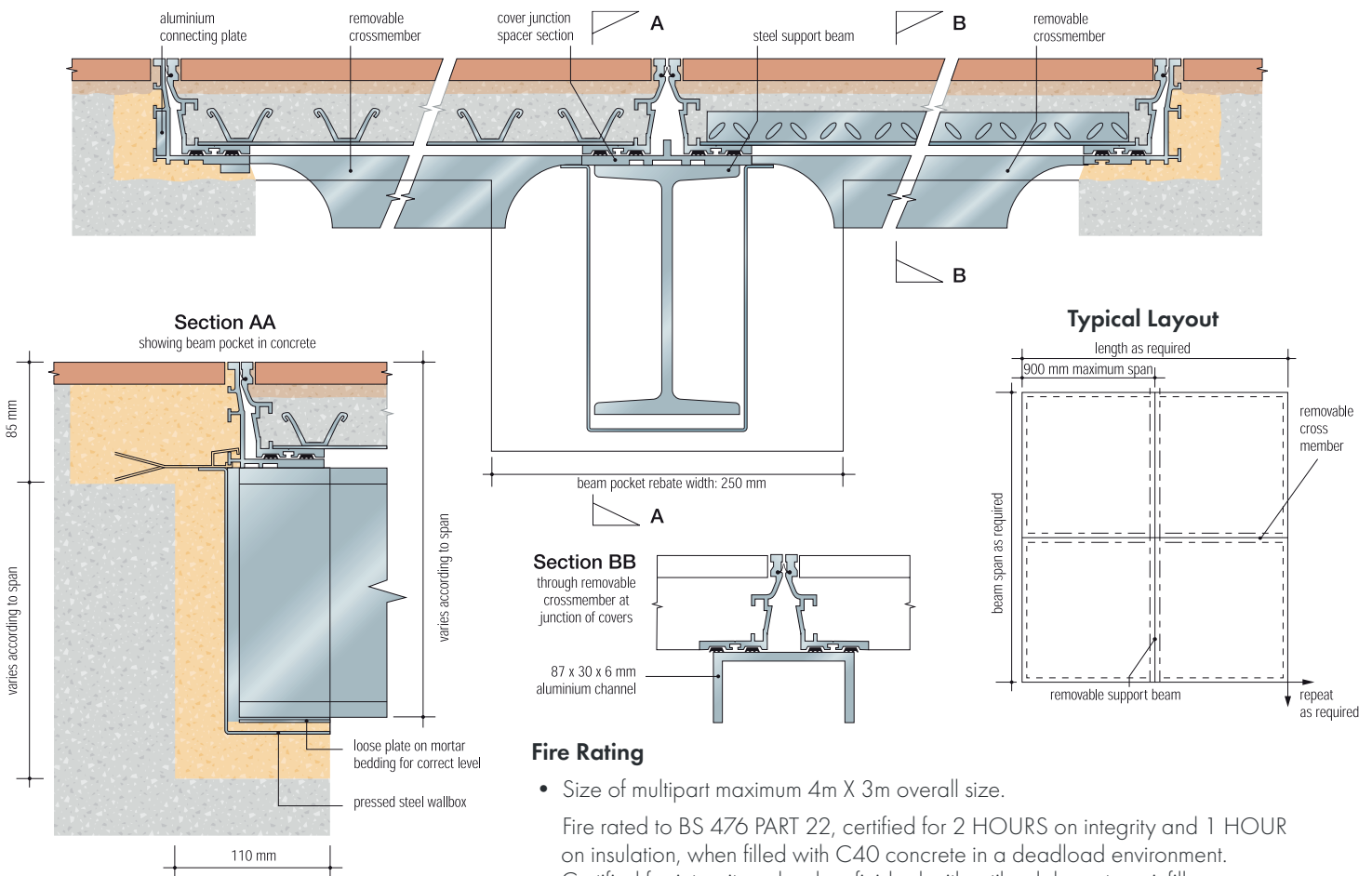

Fire Rating

- Size of multipart maximum 4m X 3m overall size.

Fire rated to BS 476 PART 22, certified for 2 HOURS on integrity and 1 HOUR on insulation, when filled with C40 concrete in a deadload environment. Certified for integrity only when finished with a tile, slab or stone infill.

» CONTACT US

Sales Enquiries

+44(0)1920 463 230 info@howegreen.co.uk www.howegreen.com

Marsh Lane, Ware, Hertfordshire, SG12 9QQ, UK

